

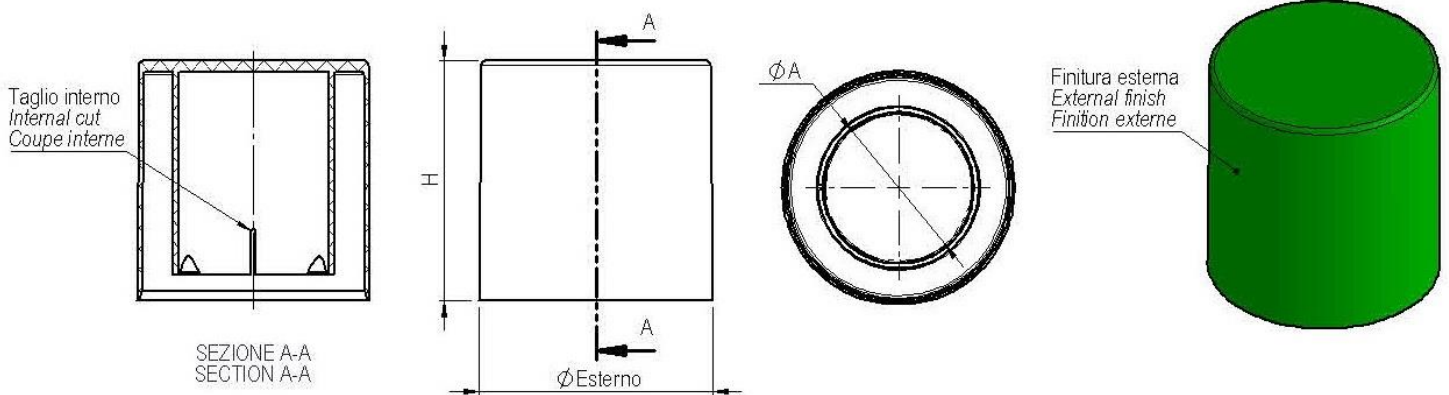





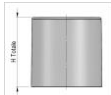
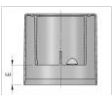
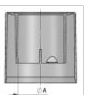

Art. cod. 00728

Descrizione / Description / Description

**Cappuccio doppio corpo**  
**Double body capsule**  
**Double capsule corporelle**

**Tabella dati tecnici / Technical data table / Tableau données techniques**

 Ø Esterno (mm)	 Altezza H(mm)	 Altezza E(mm)	 Ø Aggancio A(mm)	 Finitura esterna	 Foro	 Taglio interno	 Materiale	 Masterbatch	 Peso (g)
<i>External ø (mm)</i>	<i>Height H(mm)</i>	<i>Height E(mm)</i>	<i>ø Hooking A(mm)</i>	<i>External finish</i>	<i>Hole</i>	<i>Internal cut</i>	<i>Material</i>	<i>Masterbatch</i>	<i>Weight (g)</i>
<i>ø Extérieur (mm)</i>	<i>Hauteur H(mm)</i>	<i>Hauteur E(mm)</i>	<i>ø Crochetage A(mm)</i>	<i>Finition externe</i>	<i>Trou</i>	<i>Coupe interne</i>	<i>Matière</i>	<i>Masterbatch</i>	<i>Poids (g)</i>
50	51,6	5,5	31,5	Lucido/Glossy/ Brillant	no/no/ non	Si/yes/oui	PP Food contact	Food contact	15,7
50	51,6	5,8	31,5	Lucido/Glossy/ Brillant	no/no/ non	Si/yes/oui	PP Food contact	Food contact	15,6
50	51,6	7,5	31,5	Lucido/Glossy/ Brillant	no/no/ non	Si/yes/oui	PP Food contact	Food contact	15,4
50	51,6	13,2	31,5	Lucido/Glossy/ Brillant	no/no/ non	Si/yes/oui	PP Food contact	Food contact	14,7
50	51,6	14,2	31,5	Lucido/Glossy/ Brillant	no/no/ non	Si/yes/oui	PP Food contact	Food contact	14,6
50	51,6	17	31,5	Lucido/Glossy/ Brillant	no/no/ non	Si/yes/oui	PP Food contact	Food contact	14,2
50	51,6	23,7	31,5	Lucido/Glossy/ Brillant	no/no/ non	Si/yes/oui	PP Food contact	Food contact	13,4

Il peso indicato è puramente indicativo e non valido ai fini CONAI.

The weight indicated is purely indicative.

Le poids indiqué est indicatif.

## Tabella dati imballaggio-spedizione / Table packing and shipping details / Table données d'emballage-expédition

Scatola standard (cm)	Sacchetto	Quantità per scatola	Quantità per pallet	Pallet (cm)
<i>Standard box (cm)</i>	<i>Bag</i>	<i>Pcs box</i>	<i>Pcs pallet</i>	<i>Pallet (cm)</i>
Carton standard (cm)	Sachet	Pcs carton	Pcs palette	Palette (cm)
60x40 H:33,5	PE Food contact	450	5400	120x80 H:112

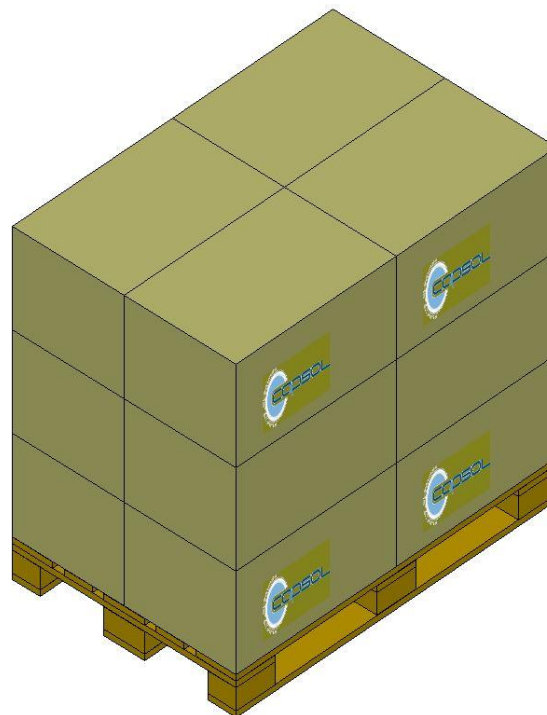

### Stoccaggio / Storage / Stockage

Conservare i prodotti nella loro confezione originale in un luogo pulito, fresco e asciutto.

*Store the products in their original packaging in a clean, cool and dry place.*

*Stocker les produits dans leur emballage d'origine dans un endroit propre, frais et sec.*

Temperatura / Temperature / Temperature : **5÷30°C**

Umidità / Humidity / Humidité : **45÷75%**

Conservare i prodotti a temperatura ambiente (**20°C**) per **24 ore** prima dell'uso sulla macchina confezionatrice.

*Store the products at room temperature (20°C) for 24H before using on packaging machine.*

*Stocker les produits à température ambiante (20°C) pendant 24 heures avant l'utilisation sur la machine d'emballage.*