

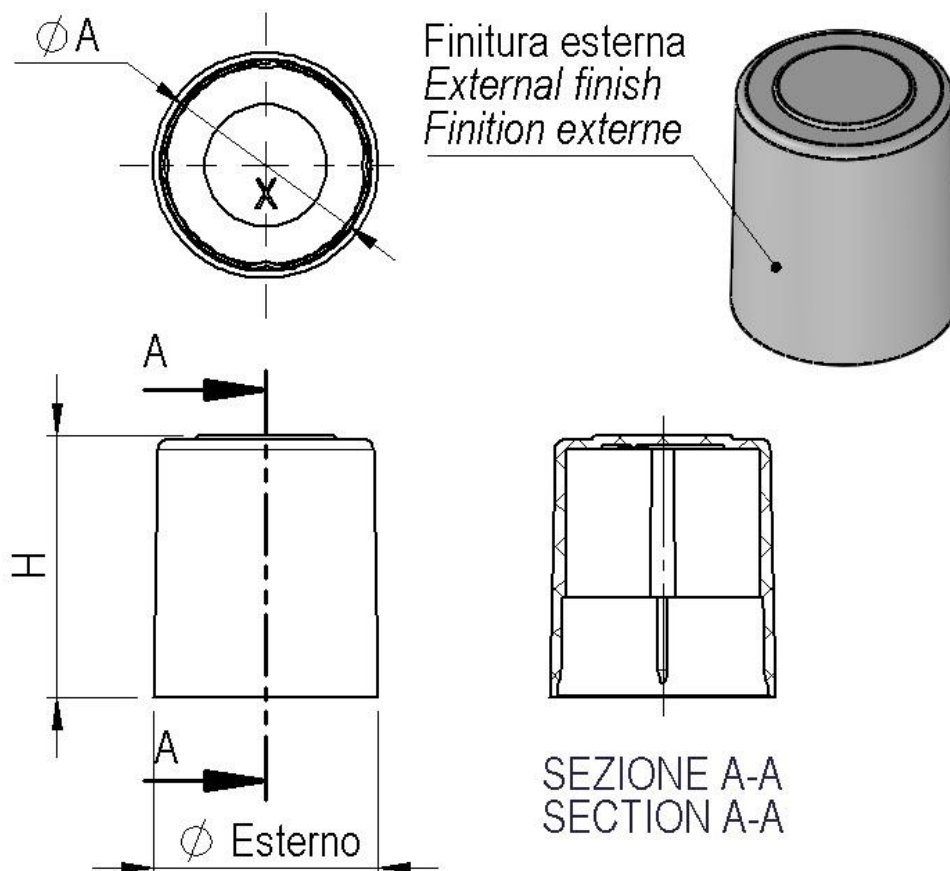





Art. cod. 00024
Descrizione / Description / Description
Cappuccio copri-valvola
Capsule, valve cover
Capsule, couvercle de valve

Tabella dati tecnici / Technical data table / Tableau données techniques

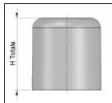
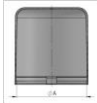
					
ϕ Esterno (mm)	Altezza H (mm)	ϕ Aggancio A (mm)	Finitura esterna	Materiale	Peso (g)
External ϕ (mm)	Height H (mm)	ϕ Engagement A (mm)	External finish	Material	Weight (g)
ϕ Extérieur (mm)	Hauteur H (mm)	ϕ D'engagement A (mm)	Finition externe	Matière	Poids (g)
23,4	27,15	21,05	Satinato/Satin Satinée		1,74 \pm 0,12

Il peso indicato è puramente indicativo e non valido ai fini CONAI.

The weight indicated is purely indicative.

Le poids indiqué est indicatif.

Tabella dati imballaggio-spedizione / Table packing and shipping details / Table données d'emballage-expédition

Scatola standard (cm)	Sacchetto	Quantità per scatola	Quantità per pallet	Pallet (cm)
<i>Standard box (cm)</i>	<i>Bag</i>	<i>Pcs box</i>	<i>Pcs pallet</i>	<i>Pallet (cm)</i>
<i>Carton standard (cm)</i>	<i>Sachet</i>	<i>Pcs carton</i>	<i>Pcs palette</i>	<i>Palette (cm)</i>
50x40 H:33,5	PE Food contact	2900	52200	120x100 H:112

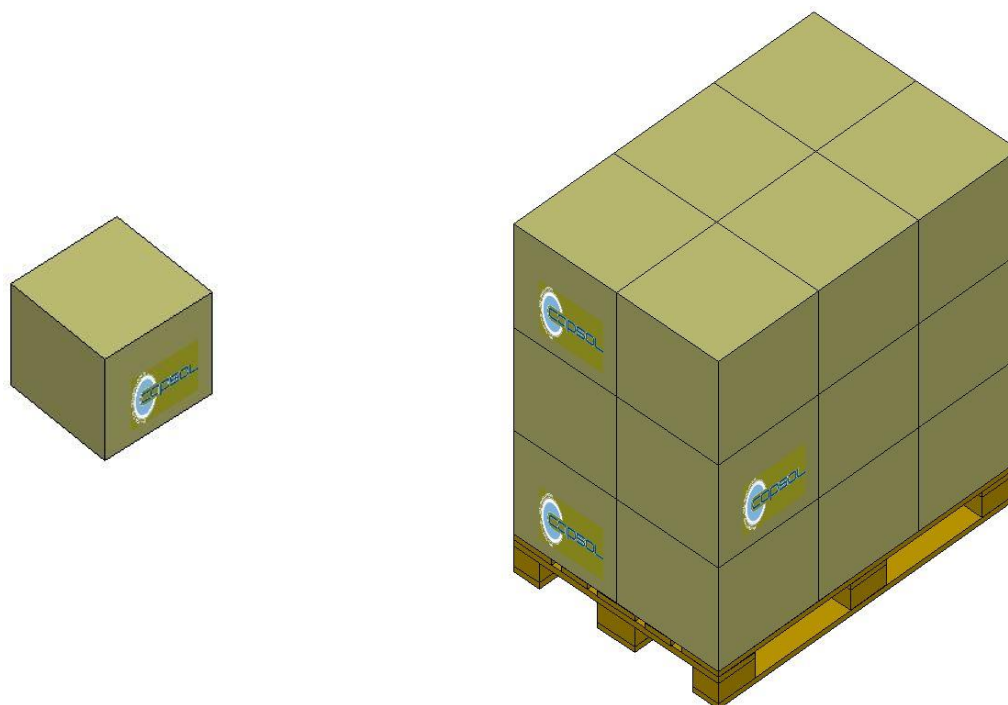

Stoccaggio / Storage / Stockage

Conservare i prodotti nella loro confezione originale in un luogo pulito, fresco e asciutto.
Store the products in their original packaging in a clean, cool and dry place.
Stocker les produits dans leur emballage d'origine dans un endroit propre, frais et sec.

Temperatura / Temperature / Temperature : **5÷30°C**

Umidità / Humidity / Humidité : **45÷75%**

Conservare i prodotti a temperatura ambiente (**20°C±5**) per **48 ore** prima dell'uso sulla macchina confezionatrice.
Store the products at room temperature (20°C±5) for 48H before using on packaging machine.
Stocker les produits à température ambiante (20°C±5) pendant 48 heures avant l'utilisation sur la machine d'emballage.